

User's manual of 280 Waterproof magnetic lock

The magnetic reaction installation sketch of the magnetic lock

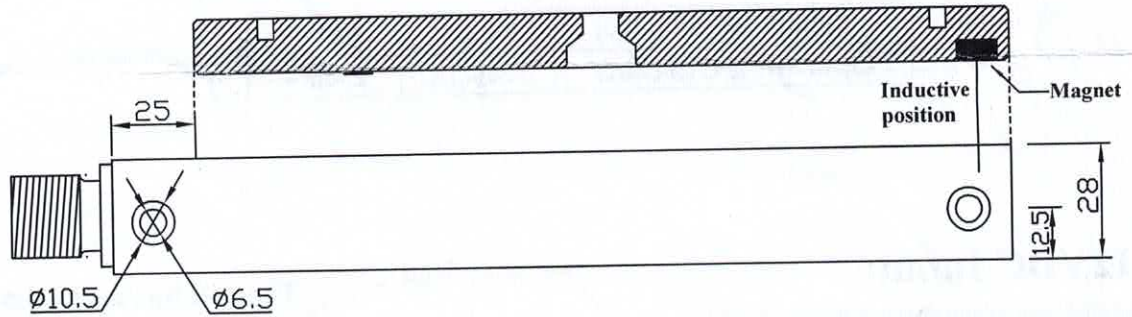

Magnetic lock dimension drawing

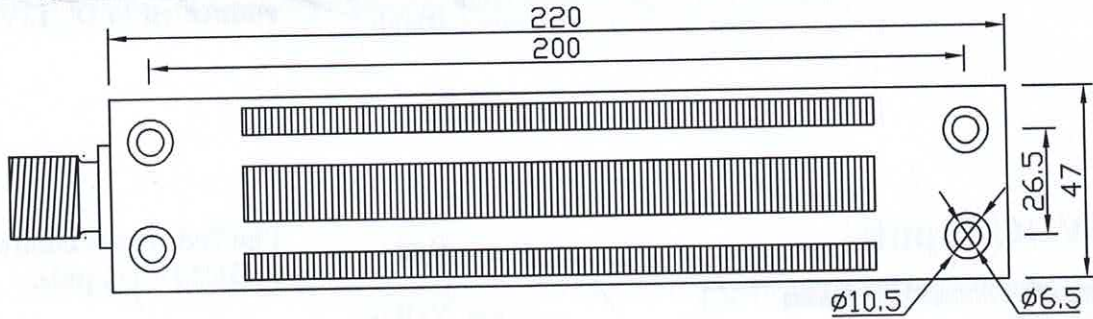

Adsorption board size chart

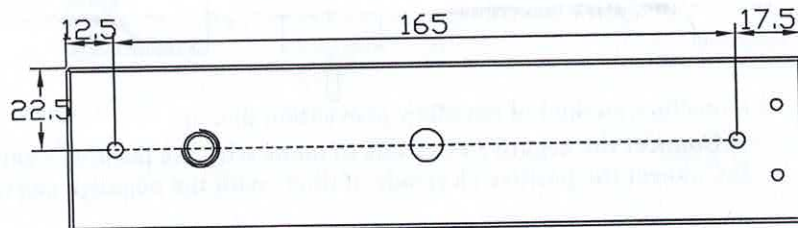
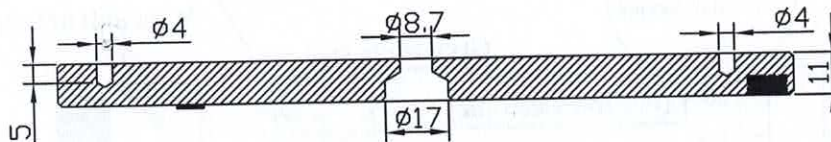
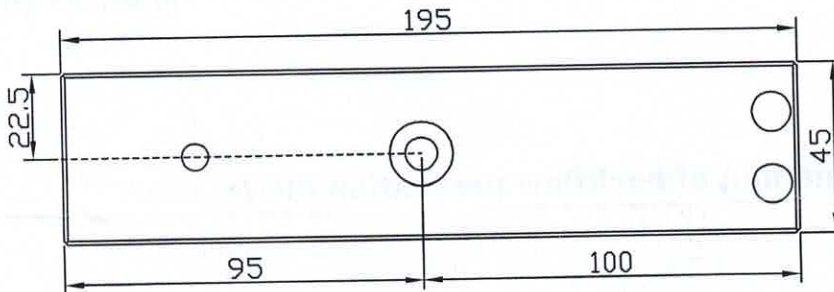

User's manual of 280 Waterproof magnetic lock

Operating Voltage:	DC12V	DC24V
Operating Current:	500mA	250mA

A. 12VDC Input:

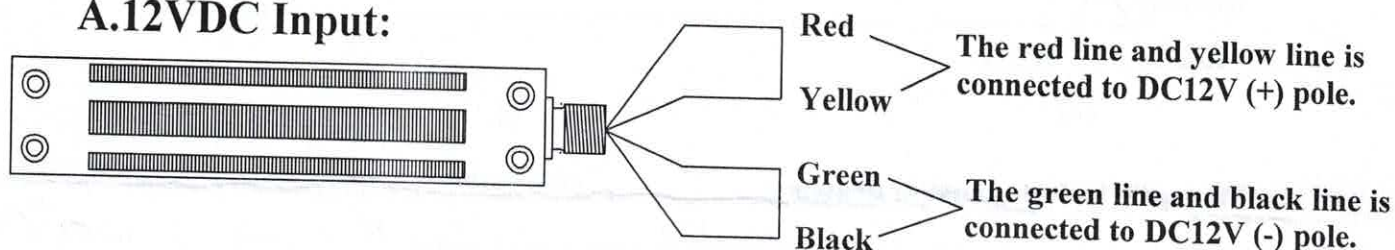

B. 24VDC Input:

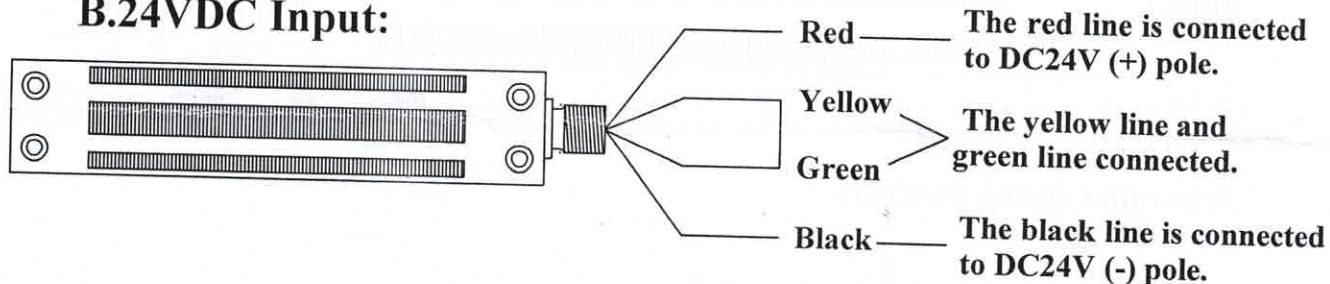

C. Connection method of backflow prevention diode:

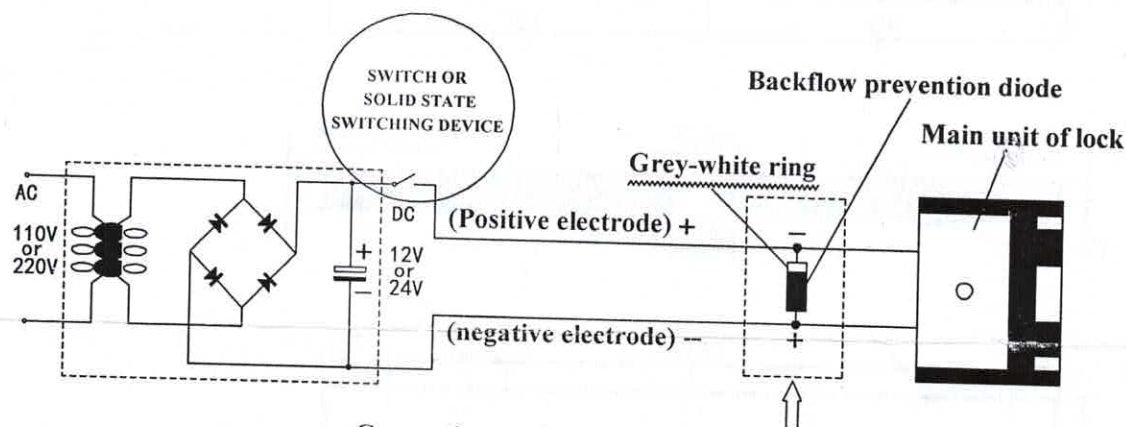

Connection method of backflow prevention diode:

- Connect the negative electrode of diode with the positive electrode of lock body.
- Connect the positive electrode of diode with the negative electrode of lock body.